

nt

Folding Table



okamura

**For any spaces,
for any occasions...**

NT delivers the flexibility you need to use your spaces effectively.



Training sessions



Brainstorming



Flexibility
for creative workspaces

Straight nesting

Straight nesting for efficient storage; large casters for smooth and easy movement.

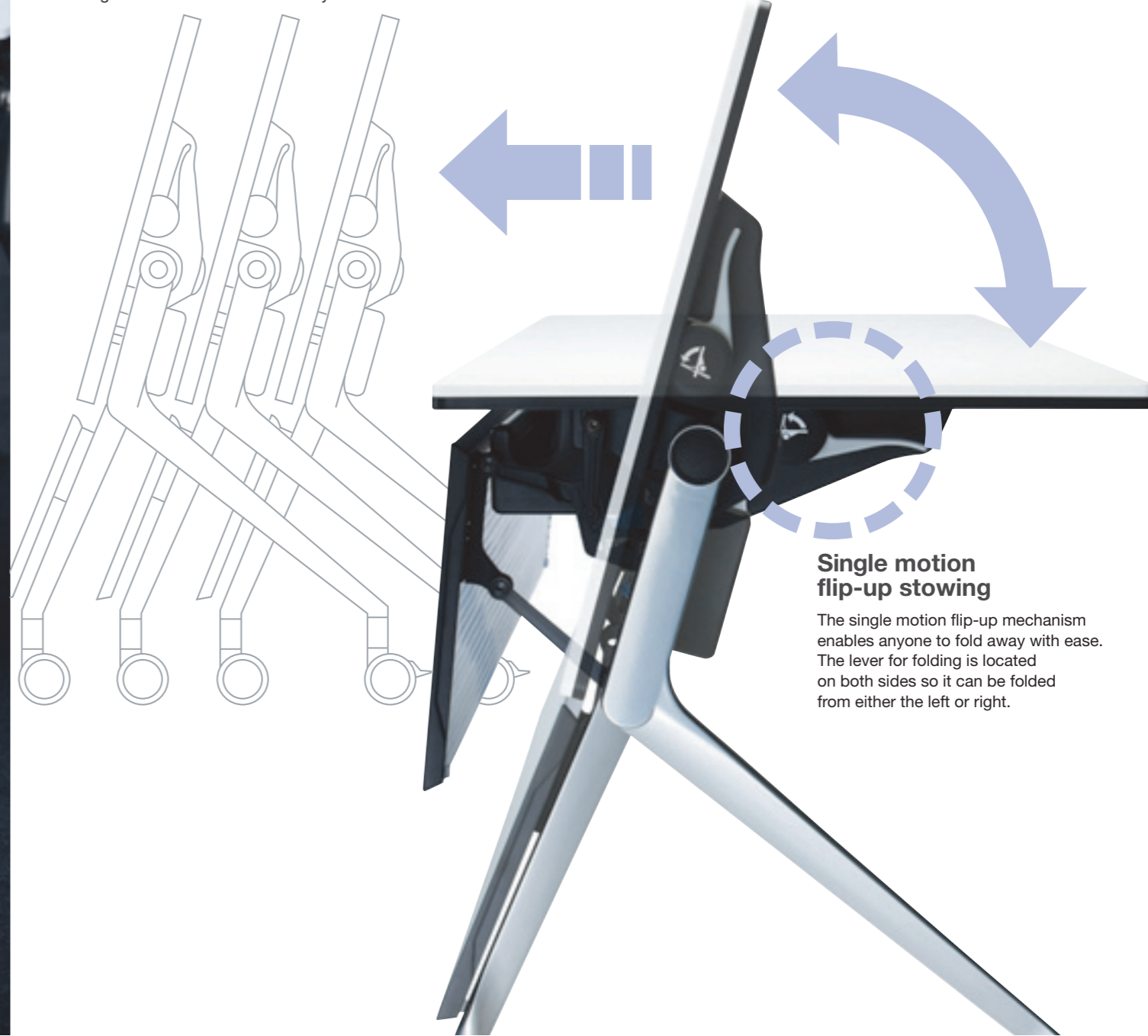

**Single motion
flip-up stowing**

The single motion flip-up mechanism enables anyone to fold away with ease. The lever for folding is located on both sides so it can be folded from either the left or right.



Full view



Level adjustable:
Casters are individually level adjustable within 0- $\frac{3}{8}$ inch (0-10mm) to allow for uneven floors.

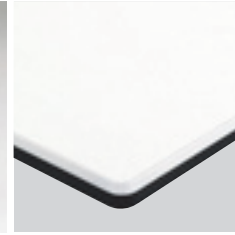

Tabletop color: White
MH47



Tabletop color: Light Plain
MH46

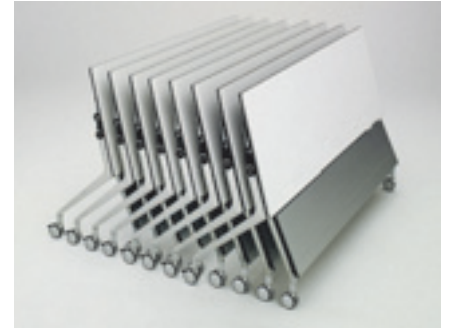
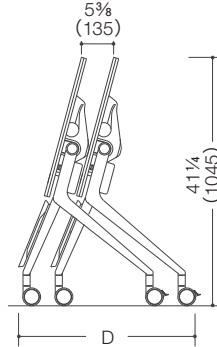
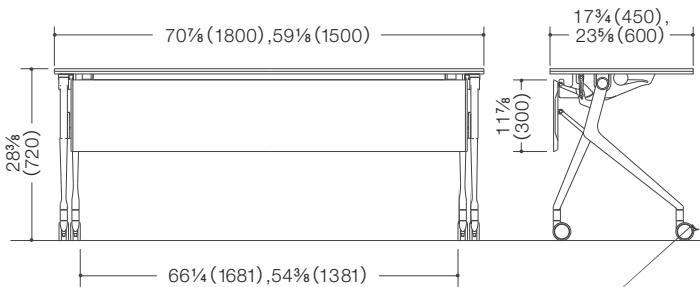

Space required for nested storage:
17 $\frac{3}{4}$ (450)D: 19(480) + (number of tables-1) \times 5 $\frac{3}{8}$ (135)
23 $\frac{3}{8}$ (600)D: 24 $\frac{7}{8}$ (630) + (number of tables-1) \times 5 $\frac{3}{8}$ (135)

inch (mm)

Size variations

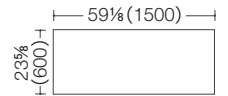
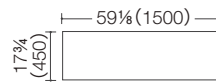
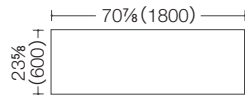
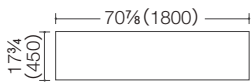

inch (mm)

Options:

Modesty panel, Document shelf

Materials:

Tabletop: laminated melamine
Edge finish: ABS
Legs: die cast aluminum
Modesty panel: ABS

Environmental aspects:

54% recyclable
Contains 58% recycled materials
Designed for disassembly
Major components are labeled for ease of recycling
All company activities managed by ISO 14001 system

Specifications:

Single motion flip-up mechanism
Nestable for straight storage and stowing
Wiring features
Level adjustable max $\frac{3}{8}$ inch (10mm)
3inch (75mm) dia. casters for easy moving
 $\frac{7}{8}$ inch (22mm) thickness tabletop with two-tone edge
Max. bearing weight: 60kg (uniformly distributed)

Standards:

EN527-1/2/3

The products listed in this catalog are available as of August 2012. Please note that specifications, dimensions, and colors are subject to change without notice. The colors of the actual products may differ somewhat from the colors shown in the catalog, depending on printing conditions.

THANK YOU !!!



Channel Partners:

B-122, Sector-67, Noida -201301, India

Mobile: +91 9818797744

Email: sales@indoinnovations.com

Website: www.indoinnovations.com