

nt

Folding Table



okamura



**For any spaces,  
for any occasions...**

NT delivers the flexibility you need  
to use your spaces effectively.



Training sessions



Brainstorming

**Straight nesting**

Straight nesting for efficient storage;  
large casters for smooth and easy movement.

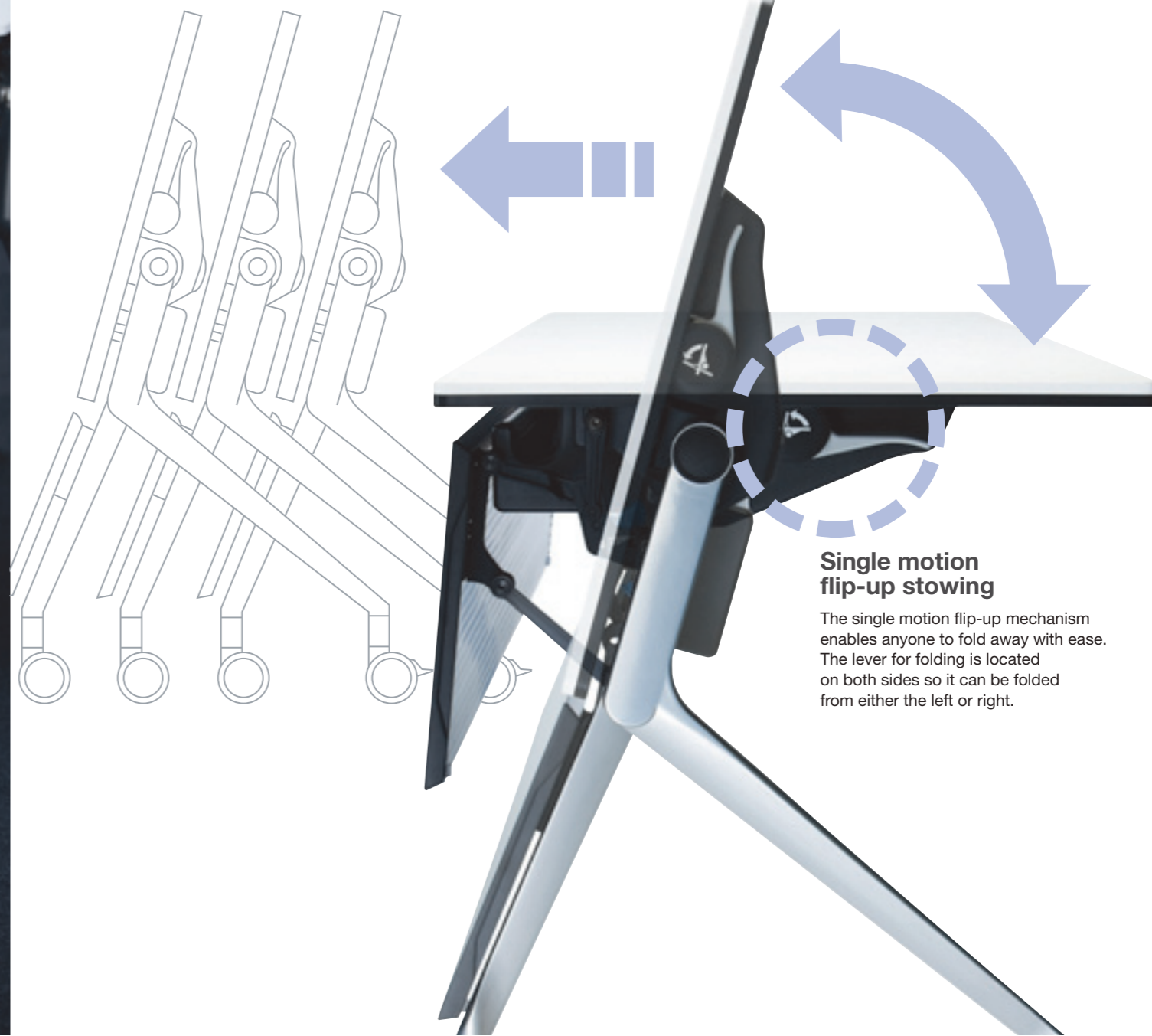

**Single motion  
flip-up stowing**

The single motion flip-up mechanism  
enables anyone to fold away with ease.  
The lever for folding is located  
on both sides so it can be folded  
from either the left or right.

**Flexibility**  
for creative workspaces



Full view



Level adjustable:  
Casters are individually level adjustable within 0- $\frac{3}{8}$ inch (0-10mm) to allow for uneven floors.

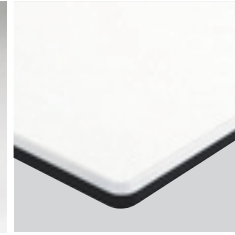

Tabletop color: White  
MH47



Tabletop color: Light Plain  
MH46

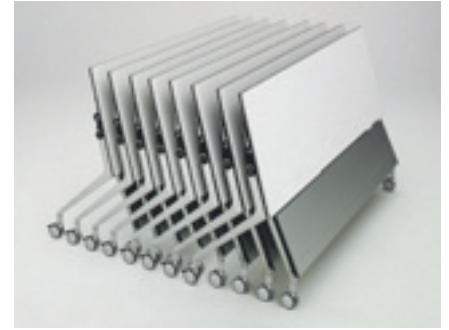
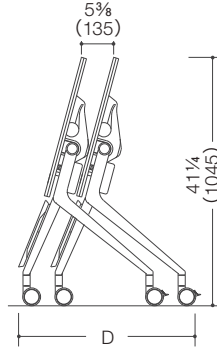
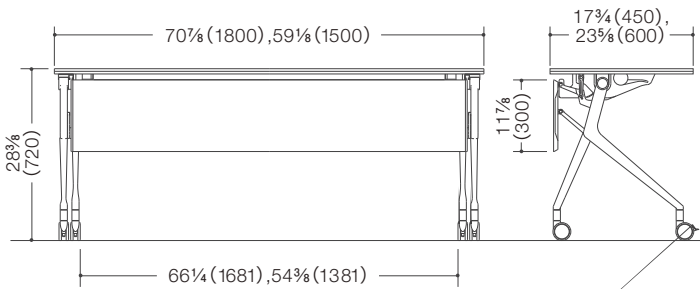

Space required for nested storage:  
17 $\frac{3}{4}$ (450)D: 19(480) + (number of tables-1)  $\times$  5 $\frac{3}{8}$ (135)  
23 $\frac{3}{8}$ (600)D: 24 $\frac{7}{8}$ (630) + (number of tables-1)  $\times$  5 $\frac{3}{8}$ (135)

inch (mm)

**Size variations**

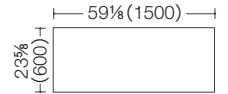
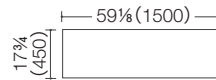
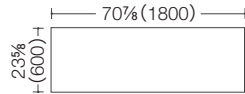
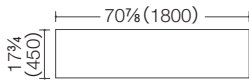

inch (mm)

**Options:**

Modesty panel, Document shelf

**Materials:**

Tabletop: laminated melamine  
Edge finish: ABS  
Legs: die cast aluminum  
Modesty panel: ABS

**Environmental aspects:**

54% recyclable  
Contains 58% recycled materials  
Designed for disassembly  
Major components are labeled for ease of recycling  
All company activities managed by ISO 14001 system

**Specifications:**

Single motion flip-up mechanism  
Nestable for straight storage and stowing  
Wiring features  
Level adjustable max  $\frac{3}{8}$ inch (10mm)  
3inch (75mm) dia. casters for easy moving  
 $\frac{7}{8}$ inch (22mm) thickness tabletop with two-tone edge  
Max. bearing weight: 60kg (uniformly distributed)

**Standards:**

EN527-1/2/3

The products listed in this catalog are available as of August 2012. Please note that specifications, dimensions, and colors are subject to change without notice. The colors of the actual products may differ somewhat from the colors shown in the catalog, depending on printing conditions.

# THANK YOU !!!



Channel Partners:

B-122, Sector-67, Noida -201301, India

Mobile: +91 9818797744

Email: [sales@indoinnovations.com](mailto:sales@indoinnovations.com)

Website: [www.indoinnovations.com](http://www.indoinnovations.com)